

## Contents

<b>1</b>	<b>Operating and assembly instructions</b>	<b>1</b>
<b>2</b>	<b>General information on these instructions</b>	<b>1</b>
2.1	Standards and guidelines	1
2.2	Intended use	2
2.3	Foreseeable misuse	2
2.4	Warranty and liability	2
2.5	Customer service provided by the manufacturer	2
<b>3</b>	<b>Safety</b>	<b>2</b>
3.1	General safety instructions	2
3.2	Layout of safety instructions	2
<b>4</b>	<b>Product description</b>	<b>3</b>
4.1	Product contents	3
4.2	Accessories	3
<b>5</b>	<b>Assembly</b>	<b>3</b>
5.1	Mechanical fastening	4
5.2	Electrical connection	4
5.3	Connection example for RoIMotion M 230 V / 50 Hz	5
5.4	Parallel circuit	5
5.5	Commissioning	5
5.5.1	Connection for assembly cable	5
5.6	Setting the end positions	5
5.6.1	Changing/deleting the end positions	5
5.6.2	Four variants of end position settings	5
5.6.3	Variant A: Upper and lower end position freely adjustable	6
5.6.4	Variant B: Fixed upper limit stop, lower end position freely adjustable	6
5.6.5	Variant C: Fixed upper and lower limit stop	6
5.6.6	Variant D: Upper end position freely adjustable, fixed lower limit stop	6
5.7	Placement of roller blind slats	7
<b>6</b>	<b>Travel profiles</b>	<b>7</b>
6.1	Travel profile default mode	7
6.2	Travel profile whisper mode	7
<b>7</b>	<b>Troubleshooting</b>	<b>7</b>

<b>8</b>	<b>Servicing</b>	<b>7</b>
<b>9</b>	<b>Service/manufacturer's address</b>	<b>7</b>
<b>10</b>	<b>Repairs</b>	<b>7</b>
<b>11</b>	<b>Disassembly and disposal</b>	<b>7</b>
<b>12</b>	<b>Comments on EU Declaration of Conformity</b>	<b>8</b>
<b>13</b>	<b>Technical data and dimensions</b>	<b>8</b>
13.1	RoIMotion M	8

## RoIMotion M Roller Blind Drive

### 1 Operating and assembly instructions

Follow these instructions for safe and proper use. Observe all assembly instructions. Incorrect assembly can lead to serious injuries. Please keep this operating manual for future reference to ensure that it can be accessed throughout the entire service life of the product!

**The German operating manual is the original version.**

All documents in other languages are translations of the original version.

All rights reserved in the case of patent, utility model or design registrations.

### 2 General information on these instructions

The content structure is based on the life cycles of the electric motor drive (hereinafter referred to as "the product").

The manufacturer reserves the right to make changes to the technical data in these operating instructions. In some cases, this technical data may differ from those of the respective product version; however, the functional information will not undergo significant changes or become invalid. The current version of the technical specifications may be requested from the manufacturer at any time.

No claims may be asserted against the manufacturer as a result of this provision. Deviations from textual or visual statements may occur depending on the product's technical development, features and accessories. Deviating information for special versions will be provided by the manufacturer in the sales documentation. Other information shall remain unaffected by these provisions.

#### 2.1 Standards and guidelines

During construction, the fundamental health and safety requirements were applied and provision was made for the appropriate legislation, standards, directives and guidelines. The safety of the product is confirmed by the declaration of conformity (see EC Declaration of Conformity). All information relating to safety in these operating instructions refers to the laws and regulations that are currently valid in Germany. All information in these operating instructions must be complied with at all times and without limitation. In addition to the safety notes in these operating instructions, the regulations on accident prevention, environmental protection and occupational health and safety applicable at the location of use must be observed and adhered to. The regulations and standards for safety assessment can be found in the EC Declaration of Conformity.

## 2.2 Intended use

The product is intended for use in facade constructions as a drive for electrically powered roller shutters and blinds.

The **elero** calculation program is central to defining the drive.  
[www.elero.de/antriebsberechnung/](http://www.elero.de/antriebsberechnung/)

Other applications must be agreed upon in advance with the manufacturer, **elero** GmbH Antriebstechnik (see "Address").

The plant operator shall be solely responsible for any damages arising from the improper use of this product. The manufacturer cannot be held liable for personal or material damages caused by misuse or procedural errors, nor by improper operation or commissioning.

The product may only be operated by instructed and authorised specialist personnel while observing all safety notes.

The safe and error-free use and operational reliability of the product are only guaranteed when it is used properly according to the specifications contained in these operating and assembly instructions.

Only use radio receivers with equipment and units approved by the manufacturer. The operator has no protection whatsoever from interferences by other radio emitters and local terminals (e.g. also from radio systems), that are normally used on the same frequency range. Radio systems must not be operated in areas with an increased risk of interference (e.g. hospitals, airports). The radio control is only permitted for devices and units with which a functional interference in hand-held/wall transmitters or receivers poses no danger for persons, animals or materials or where this risk is covered by other safety appliances.

Use according to its intended purpose includes the observation and compliance of all safety instructions contained in these operating instructions as well as all valid trade Accident Insurance regulations and valid laws on environmental protection. Use according to its intended purpose also includes the compliance with all prescribed operating regulations in these operating and assembly instructions.

## 2.3 Foreseeable misuse

Any use that deviates from the intended use as stated by the manufacturer, **elero** GmbH Antriebstechnik (see "Address") is deemed as foreseeable misuse.

## 2.4 Warranty and liability

The General Terms and Conditions of the manufacturer, **elero** GmbH Antriebstechnik, apply at all times (see "Address"). The conditions of sale and delivery are included in the sales documents and shall be presented to the plant operator upon delivery. Any liability claims for personal or material damages are excluded when they can be attributed to one or more of the following causes:

- Opening the product by the customer
- Improper use of the product
- Improper installation, commissioning or operation of the product
- Structural modifications to the product without the written consent of the manufacturer
- Operation of the product with improperly installed connections, defective safety devices or improperly installed safeguards
- Failure to observe the safety regulations and information presented in these operating instructions
- Failure to observe the specified technical data

## 2.5 Customer service provided by the manufacturer

In the event of a fault, the product may only be repaired by the manufacturer. The address for sending the product to Customer Service can be found in the Section "Address". If you did not purchase the product directly from **elero**, please contact the supplier of the product.

# 3 Safety

## 3.1 General safety instructions

General safety instructions for use of tubular drives can be found in the "Safety instructions" leaflet supplied with each drive (leaflet article number 138200001). These operating and assembly instructions contain all the safety information that must be observed in order to avoid and prevent danger when working with the product in the individual life cycles. When all specified safety instructions are complied with, safe operation of the device is guaranteed.

## 3.2 Layout of safety instructions

The safety instructions in this document are marked using hazard and safety symbols and are designed according to the SAFE principle. They contain information on the type and source of the danger, possible consequences and on avoiding danger.

The following table defines the representation and description of hazard levels with possible physical damage as used in these operating instructions.



Symbol	Signal word	Meaning
	DANGER	Warns about an accident that will occur if the instructions are not followed, which can lead to fatal, irreversible injuries or death.
	WARNING	Warns about an accident that may occur if the instructions are not followed, which can lead to serious, possibly fatal, irreversible injuries or death.
	CAUTION	Warns about an accident that can occur if the instructions are not followed, which can lead to slight, reversible injuries.

Fig. 1 Notation for personal injuries

The table below describes the pictograms used in these operating instructions to illustrate the hazard situation in relation with the symbol for the hazard level.

Symbol	Meaning
	Danger caused by electrical voltage, electric shock: This symbol indicates dangers due to electric current.

Fig. 2 Notation for specific danger

The table below defines the representation and description of situations used in these operating instructions for situations in which damage can occur to the product or indicates important facts, conditions, tips and information.



Symbol	Signal word	Meaning
	ATTENTION	This symbol warns against possible damage to property or equipment.
	IMPORTANT	This symbol indicates important facts and states as well as referring to further information in these operating and assembly instructions. It also refers to certain additional instructions, which provide additional information or help you to carry out a procedure more simply.
		Symbol indicating successful grounding with protection class I (Protective conductor system)

Fig. 3 Notation for damage to property and additional information

The following example illustrates the basic structure of a safety note:

 **SIGNAL WORD**

Type and source of danger

Explanation of type and source of danger

- ▶ Measures to avoid the danger

## 4 Product description

The RolMotion M is an electromechanical tubular drive for roller blinds and textile sun protection. During operation it executes radial movements.

- Commissioning of the RolMotion M with **elero** assembly cable or radio transmitter for setting various functions.
- Blind protection with free travel (torque limiting).
- Relief function for the blind (blind protection).
- Cyclical reference runs compensate for changes in the winding behaviour of the roller blind slats.
- In addition to the usual travel profile (travel profile standard), the RolMotion M drive also has a reduced-speed travel profile (motion travel profile).
- Slow travel when placing the roller blind slats.
- Slow travel with timed release.

### 4.1 Product contents

Drive with safety instructions and operating instructions and any additional components and accessories according to the order confirmation or delivery note.

### 4.2 Accessories

Connection and assembly cable, adapter sets, motor bearing, ProLine control units, sensors, receivers.

## 5 Assembly

 **WARNING**

Important safety instructions

Observe all assembly instructions. Incorrect assembly can lead to serious injuries.

- ▶ Commissioning of the RolMotion M with elero assembly cable for setting various functions.
- ▶ Before installation, all cables and components that are not required and all facilities that are not needed for operation with a power drive are to be disabled.
- ▶ The required components are: drive, connection and assembly cable, motor bearing, adapter sets, if necessary rigid shaft connectors, sensors, control devices, receivers.
- ▶ If components are not delivered with the drive, these can be identified via our catalogue "Drives and control units for intelligent building technology" in the relevant valid version. Further details can be found on our website under "Contact - dealer search" and "Contact - contact persons for specialist companies".
- ▶ The rated torque and rated operating time must be suitable for the properties of the driven part (the blind).
- ▶ The coupling of the drive with the powered part is described in the section "Mechanical fastening".

 **CAUTION**

Risk of injuries due to hot surfaces.

The drive will heat up during operation, the drive casing can become hot. Skin burns are possible.

- ▶ Wear personal protection equipment (protective gloves).
- Triggered by a possible material fault, knocks or impact injuries may arise due to a gear fracture, burring fracture or a coupling defect.
- ▶ Suitable materials have been used for the engineering design and random sample testing by means of a double load test has been performed in accordance with DIN EN 60335-2-97.

Risk of injury due to knocks or impact triggered by motor bearings that are incorrectly mounted or engaged. Hazard due to insufficient stability or steadiness and accumulated energy (gravity).

- ▶ Selection of motor bearing by torque specifications.
- ▶ The drive must be protected with all the enclosed safety devices.
- ▶ Check for correct engagement on motor bearing and the correct screw tightening torques.

 **WARNING**

Risk of injury due to electric current.



Risk of electric shock.

- ▶ Always have electrical work carried out by an authorised electrician.

Risk of injury due to electric current.



Possible danger due to parts that are faulty becoming energised.

- ▶ The drive falls under protection class I (protective conductor system). All housing parts of the drive capable of conducting electricity are connected with the protective

conductor system of the fixed electrical installation, which is located at potential earth. The protective conductor connection is designed so that, the first time the plug is inserted, it is connected first and, in case of any damage, it is disconnected last. The connecting cable is fitted with mechanical strain-relief when inserted in the drive. If the cable is torn out, the protective conductor will be torn off last. If, in case of a fault, a live cable comes into contact with the housing, which is connected with the protective conductor, a short circuit will generally arise so that the fuse itself is triggered and de-energizes the electric circuit. No electricity will be conducted to human beings in case of a fault. 4-core connecting cables (4 x 0.75 mm<sup>2</sup> cross-section with black CONINVERS plug) are used for the electrical connection with an earthing contact that is conducted to the exterior.

## CAUTION

Risk of injury due to malfunctions as a result of incorrect assembly.

Drive is overwound and may destroy parts of the application.

- ▶ For safe operation, the end positions must be set/taught in.
- ▶ Manufacturer training is available for specialist companies.

## ATTENTION



Power failures, breaking of machine parts and other malfunctions.

- ▶ For safe operation, assembly must be correct and the end position adjustments will have to be carried out upon commissioning.



Damage to RolMotion due to ingress of moisture.

- ▶ On devices with protection class IP 44, the ends of all cables or plugs will need to be protected from ingress of moisture. This measure needs to be implemented immediately after removing the RolMotion M from the original packaging.
- ▶ The drive must be installed so that it cannot get wet.

### Important



In its delivery condition (factory setting), the RolMotion M will be in commissioning mode.

- ▶ The end positions will need to be set (see section 5.6).

## 5.1 Mechanical fastening

### Important preliminary consideration:

The working area around the installed drive is usually very small. For this reason, obtain an overview of how the electrical connection has been implemented prior to the mechanical installation (see section 5.2) and make the necessary changes beforehand.

## ATTENTION



Crushing or tension will damage the electrical cables.

- ▶ Install all electrical cabling so that it is not subject to any crushing or tensile load
- ▶ Observe the bending radii of cables (at minimum 50 mm).
- ▶ Route connecting cables in a downward loop to prevent water running into the drive.



Damage to the drive due to the effect of impact forces.

- ▶ Slide the drive into the shaft. Never knock the drive in or use force!

- ▶ Take care not to drop the drive!



Damage or destruction to the drive by drilling.

- ▶ Never drill the drive!

### Important



Only fasten the RolMotion M to the designated fastening elements.

Fixed installed control devices need to be attached so they are visible.

- The blind must be attached to the winding shaft.
- The profile tube must have sufficient clearance from the motor tube.
- Make sure there is sufficient axial play (1 - 2 mm)

### Installation in profile tubes

Ⓐ Push drive with relevant adapter and crown into the profile tube.

Install the motor cable so it is protected to prevent damage from the driven part.

Ⓑ Secure the counterpart support to prevent axial movement, e.g. screw or rivet on the idler.

Secure the drive axially in the support!

Ⓒ Attach the blind to the shaft.

Only operate the drive horizontally, as intended, with the connection cable leading out from the side and out of the blind winding area.

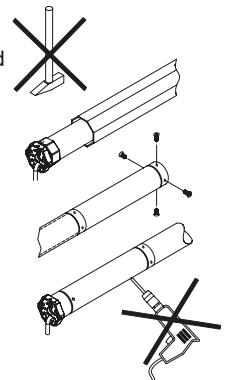

## 5.2 Electrical connection



### WARNING

Faulty electrical connections constitute a fatal hazard.



Risk of electric shock.

- ▶ Prior to initial commissioning, check the PE wire is correctly connected.



### ATTENTION



Damage to the RolMotion M due to incorrect electrical connection.

- ▶ Prior to initial commissioning, check the PE wire is correctly connected.



Ingress of moisture will damage or even destroy the RolMotion M.

- ▶ For devices with protection class IP 44, the customer-side connection of the cable ends or plugs (cable feed-through) can also be implemented according to protection class IP 44.



Damage or destruction of the RolMotion M for variants with 230 V ~ due to incorrect activation.

- ▶ Switches with an OFF presetting (dead-man's switches) for drives are to be attached within visible range of the RolMotion M but away from spontaneously moving parts and at a height of more than 1.5 m.

**Connect only in de-energised state. To do this, switch the drive cable so it is de-energised.**

- 1 Press locking mechanism on the motor cable plug towards the cable using a suitable screwdriver.
- 2 Pull out the plug.
- 3 Insert the motor cable plug until the lock engages.

Removing and inserting the motor cable plug		
Delivery condition	Removing plug	Inserting plug

Fig. 4 Removing and inserting the motor cable plug

### 5.3 Connection example for RoIMotion M 230 V / 50 Hz

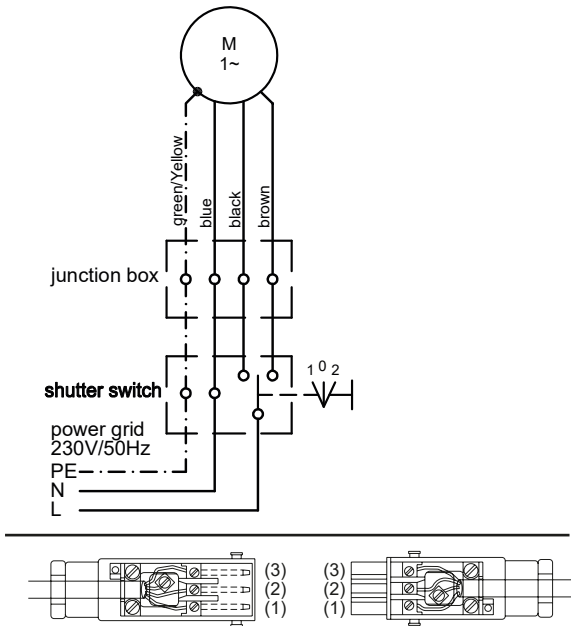

Fig. 5 Connection diagram RoIMotion M 230 V / 50 Hz and cable assignment when using Hirschmann plug connection STAS-3

**Important**  
The motor controls in the Open and Down/Closed travel directions must be locked against each other.

A switching time of at least 0.5 seconds must be observed.

### 5.4 Parallel circuit

**Important**

You can connect up to 3 (maximum) RoIMotion M in parallel. Please note the maximum switching capacity of the control unit.

However, the behaviour of the devices is not synchronous. Do not connect the RoIMotion M drive in parallel with other drives (e.g. elero RoITop M).

### 5.5 Commissioning

**Important**

- The drive is in commissioning mode when delivered.
- ▶ The end positions must be adjusted using the **elero** assembly cable (see Fig. 6).
- ▶ The assembly cable may only be connected to commission the drive and for adjustment operations

### 5.5.1 Connection for assembly cable

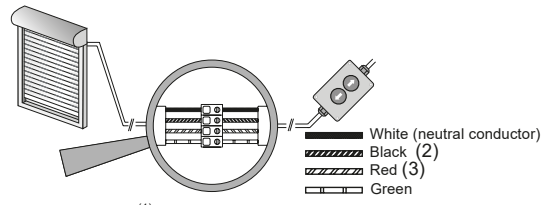

Fig. 6 Connection for assembly cable

- ▶ Switch on mains.
- ▶ You can now set the end positions with the **elero** assembly cable.

### 5.6 Setting the end positions

**Important**

To use travel profiles, the upper and lower end positions must first be set. **First program the upper end position, then the lower end position.**

The end positions and the strain relief are set

- via the **elero** assembly cable (ensure correct connection according to chapter 5.5.1)

### 5.6.1 Changing/deleting the end positions

It is not possible to change or delete individual end positions. This is always done in pairs (upper and lower end position simultaneously).

Before you can change or delete the end positions, the power supply must first be interrupted.

After a brief disconnection from the power supply, the end positions can be deleted within 5 minutes.

Changing/deleting the end positions	
1	Restore the power supply after the mains have been switched off.
2	Starting from a central blind position, use the assembly cable to simultaneously press both direction buttons [UP ▲]+[DOWN/CLOSE ▼], and hold them down until the drive briefly moves up and down.
The end position settings have been deleted. The end positions may be readjusted.	

### 5.6.2 Four variants of end position settings

Four different end position settings are possible. These can be clearly selected according to the technical requirements of the blind.

End position settings (4 variants)		possible with
<b>A</b>	Upper and lower end position freely adjustable	Suspension spring, tapes, belt
<b>B</b>	Fixed upper limit stop, lower end position freely adjustable	T-straps, tapes, belt, limit plugs, angle bracket
<b>C</b>	Fixed upper and lower limit stop	Anti push-up device, rigid shaft connectors, limit plugs, angle bracket
<b>D</b>	Upper end position freely adjustable, fixed lower limit stop	Anti push-up device, rigid shaft connectors

## Important



When programming an end position to the limit stop, the relief function for the blind is activated automatically.

The blind remains resting on the limit stop in an unstrained position.

If the blind is programmed with a fixed limit stop, reference runs are performed. Initially upon the first travel run, then cyclically later. During reference runs, the blind moves to the limit stop and then relieves itself of any strain.

The blind protection system is only adjusted after a complete, uninterrupted upwards and downwards travel.

### 5.6.3 Variant A: Upper and lower end position freely adjustable

#### Variant A: Upper and lower end position freely adjustable

- ① Starting from a central blind position, press the [UP ▲] button with the assembly cable or a programmed transmitter until the blind reaches the desired upper end position.  
The drive begins to travel, briefly stops and travels further (for as long as the [UP ▲] button remains pressed).  
You can make corrections using the [UP ▲] and [DOWN/CLOSE ▼] buttons.
- ② Press the [DOWN/CLOSE ▼] button until the drive stops automatically.  
The upper end position has been set.
- ③ Press the [DOWN/CLOSE ▼] button again until the blind has reached the desired end position.  
The drive begins to travel, briefly stops and travels further (for as long as the [DOWN/CLOSE ▼] button remains pressed).  
You can make corrections using the [UP ▲] and [DOWN/CLOSE ▼] buttons.
- ④ Press the [UP ▲] button until the drive stops automatically.  
By default, the lower end position has been set.  
Non-standard setting for the placement of the blind slats at the lower end position: See chapter 5.7.

Adjustment of the variant A end position is complete.

### 5.6.4 Variant B: Fixed upper limit stop, lower end position freely adjustable

#### Variant B: Fixed upper limit stop, lower end position freely adjustable

- ① Starting from a central blind position, press the [UP ▲] button with the assembly cable or a programmed transmitter until the blind has reached the upper end position (travels to the upper limit stop).  
The drive begins to travel, briefly stops and travels further (for as long as the [UP ▲] button remains pressed).  
The drive switches off automatically when the upper limit stop is reached.
- ② Press the [DOWN/CLOSE ▼] button until the drive stops automatically.  
The upper end position has been set.
- ③ Press the [DOWN/CLOSE ▼] button again until the blind has reached the desired lower end position.  
The drive begins to travel, briefly stops and travels further (for as long as the button remains pressed).  
You can make corrections using the [UP ▲] and [DOWN/CLOSE ▼] buttons.

#### Variant B: Fixed upper limit stop, lower end position freely adjustable

- ④ Press the [UP ▲] button until the drive stops automatically.  
By default, the lower end position has been set.  
Non-standard setting for the placement of the blind slats at the lower end position: See chapter 5.7.

Adjustment of the variant B end position is complete.

### 5.6.5 Variant C: Fixed upper and lower limit stop

#### Variant C: Fixed upper and lower limit stop

- ① Starting from a central blind position, press the [UP ▲] button with the assembly cable or a programmed transmitter until the blind has reached the upper end position (travels to the upper limit stop).  
The drive begins to travel, briefly stops and travels further (for as long as the [UP ▲] button remains pressed).  
The drive switches off automatically when the upper limit stop is reached.
- ② Press the [DOWN/CLOSE ▼] button until the drive stops automatically.  
The upper end position has been set.
- ③ Press the [DOWN/CLOSE ▼] button again until the blind has reached the desired end position (travels to the lower limit stop).  
The drive begins to travel, briefly stops and travels further (for as long as the [DOWN/CLOSE ▼] button remains pressed).  
The drive switches off automatically when the lower limit stop is reached.
- ④ Press the [UP ▲] button until the drive stops automatically.  
By default, the lower end position has been set.  
Non-standard setting for the placement of the blind slats at the lower end position: See chapter 5.7.

Adjustment of the variant C end position is complete.

### 5.6.6 Variant D: Upper end position freely adjustable, fixed lower limit stop

#### Variant D: Upper end position freely adjustable, fixed lower limit stop

- ① Starting from a central blind position, press the [UP ▲] button with the assembly cable or a programmed transmitter until the blind reaches the desired upper end position.  
The drive begins to travel, briefly stops and travels further (for as long as the button remains pressed).  
You can make corrections using the [UP ▲] and [DOWN/CLOSE ▼] buttons.
- ② Press the [DOWN/CLOSE ▼] button until the drive stops automatically.  
The upper end position has been set.
- ③ Press the [DOWN/CLOSE ▼] button again until the blind has reached the desired end position (travels to the lower limit stop).  
The drive begins to travel, briefly stops and travels further (for as long as the [DOWN/CLOSE ▼] button remains pressed).  
The drive switches off automatically when the lower limit stop is reached.

**Variant D: Upper end position freely adjustable, fixed lower limit stop**

- ④ Press the [UP ▲] button until the drive stops automatically. By default, the lower end position has been set. Non-standard setting for the placement of the blind slats at the lower end position: See chapter 5.7.

Adjustment of the variant D end position is complete.

## 5.7 Placement of roller blind slats

For slow lowering of the roller shutter bars, a standard travel path is set after programming the end positions.

It is possible to change this position when the end positions have been programmed as follows:

- After the blind starts to rise from the lower end position, hold down the [UP ▲] button until the drive starts to move further up after approx. 2 seconds. As soon as the lowest blind slat is raised from the lower limit stop, release the [UP ▲] button. This is now the position from which slow downward travel commences.

## 6 Travel profiles

The RolMotion M drive has the two travel profiles default mode and whisper mode.

### 6.1 Travel profile default mode

When travelling at high speed, only the roller blind slats are lowered slowly.

This travel is triggered by simply turning on the wall switch/button.

### 6.2 Travel profile whisper mode

Travel at slow speed along the entire travel path.

This travel is actuated by “double-clicking” at power up (On - Off - On) or during travel by switching off and on again in the same direction of travel. The duration of the switched-off state must be more than one second.

To change to the travel profile default mode, the drive must be switched off for one second.

The travel profile whisper mode is not available during the “Setting the end positions” operation.

## 7 Troubleshooting

Problem / Error	Possible cause	Remedial action
• Drive stops during travel	• End positions are not set	• Setting end positions
• Drive stops after short time	• End position programmed • Stiff blind	• Set second end position • Check the smooth running of the blind
• Drive moves in the opposite direction without a new travel command and stops after a short travel	• Obstacle in the travel area	• Remove obstacle

Problem / Error	Possible cause	Remedial action
• Drive runs only in one direction	• Faulty connection	• Check connection
• Drive does not react	• No power supply • Temperature limiter has triggered	• Check mains voltage • Allow drive to cool down
• Drive does not accept programmed end positions	• Random travel  • Travel to end position or limit stop too short	• Delete end positions, re-program end positions • Drive must move, stop briefly and continue its travel (as long as a button on the <b>elero</b> assembly cable is pressed).

Fig. 7 Troubleshooting the RolMotion M

## 8 Servicing

The RolMotion M is maintenance-free.

## 9 Service/manufacturer's address

<b>elero</b> GmbH Drive technology Maybachstr. 30 73278 Schlierbach Deutschland / Germany	Tel: +49 7021 9539-0 Fax: +49 7021 9539-212 info@elero.de www.elero.com
---	--

Please visit our website if you require a contact partner outside Germany.

## 10 Repairs

Please contact your specialist if you have any questions. Please always provide the following information:

- Item number and designation on the type plate
- Type of fault
- Accompanying conditions
- Your own theories regarding the cause of the problem

## 11 Disassembly and disposal

After unpacking, dispose of the packaging in accordance with the valid regulations.

Dispose of the product in accordance with the relevant regulations when you no longer need it. Disposal is partially subject to applicable legal regulations. Bring the product to be disposed of to authorised collection points only.

### Environmental information

No superfluous packaging materials have been used. The packaging can be easily separated into three material types: cardboard (box), polystyrene (padding) and polyethylene (bag, protective foam).

The device is made of materials that can be reused if dismantled by a specialist company. Please note the local regulations on disposal of packaging materials and old appliances.

On disassembly, additional dangers must be reckoned with, which do not occur during operation.

Before disassembling the drive the system is to be mechanically secured. The drive must not be forcibly disconnected from the system.



### WARNING

Risk of injury due to electric current.

Risk of electric shock.

- ▶ Separate power supply cables physically and discharge any energy accumulators still charged. After switching off the device, wait at least 5 minutes so that the motor can cool down and the voltage can be discharged from the capacitors.
- ▶ During disassembly work above head height, use suitable, inspected and structurally stable climbing aids.
- ▶ Work on the electrics may only be performed by personnel described in the section "Safety notes on electrical installation".

#### Removal for scrap

The international, national and regional laws and regulations prevailing at the time of scrapping the product must be observed.



Ensure that materials and components are recycled, dismantled and separated properly in addition to observing the environmental and health hazards relating to recycling and disposal.



### CAUTION

Environmental damage in case of incorrect disposal

- ▶ Electrical scrap and electronic components must be handled as special waste and may only be disposed of by approved specialist companies.
- ▶ Groups of materials such as various types of plastics and metals must be separated before recycling/disposal.

#### Disposal of electrical and electronic components

The disposal and recycling of electrical and electronic components must be carried out in accordance with the relevant laws and national regulations.

## 12 Comments on EU Declaration of Conformity

**elero** GmbH hereby declares that the RoIMotion M tubular drive is in compliance with all applicable regulations of Machinery Directive 2006/42/EC and the Directive 2014/53/EU. The full text of the EU Declaration of Conformity is available at the following Internet address:  
[www.elero.de/downloads-service/](http://www.elero.de/downloads-service/)



## 13 Technical data and dimensions

The technical data specified is subject to tolerance factors (according to applicable standards) and refer to an ambient temperature of 20 °C.



# Technical data and dimensions

## 13.1 RoIMotion M

Size / Type	RoIMotion M6	RoIMotion M10	RoIMotion M20	RoIMotion M25
Rated torque [Nm]	6	10	20	25
Rated speed default mode [1/min]	14	14	14	14
Rated speed whisper mode [1/min]	5	5	5	5
Rated voltage [V]	1 ~ 230	1 ~ 230	1 ~ 230	1 ~ 230
Rated frequency [Hz]	50	50	50	50
Noiseless soft brake	■	■	■	■
Rated current [A]	0.4	0.5	0.8	1.1
Rated power consumption [W]	92	115	184	253
Shaft diameter [mm]	50	50	50	50
Degree of protection (IP-Code)	44	44	44	44
Limit switch range (revolutions)	70	70	70	70
Operating time (min. S2)	10	10	10	10
Length C [mm]	466	466	527	556
Length D [mm]	449	449	510	539
Length E [mm] (elero, round head, star head)	14   12   19	14   12   19	14   12   19	14   12   19
Weight [kg]	1.7	1.7	2.1	2.5
Ambient operating temperature [°C]	-20 to 60	-20 to 60	-20 to 60	-20 to 60
Protection class I 	■	■	■	■
Conformity  	-,-	-,-	-,-	-,-
Plug-in connecting cable [m]	2.0	2.0	2.0	2.0
Article no. (elero head RH round head SH star head)	44 301.0001 48 301.0001 49 301.0001	44 221.0001 48 221.0001 49 221.0001	44 232.0001 48 232.0001 49 232.0001	44 242.0001 48 242.0001 49 242.0001

